

SECTION A-A

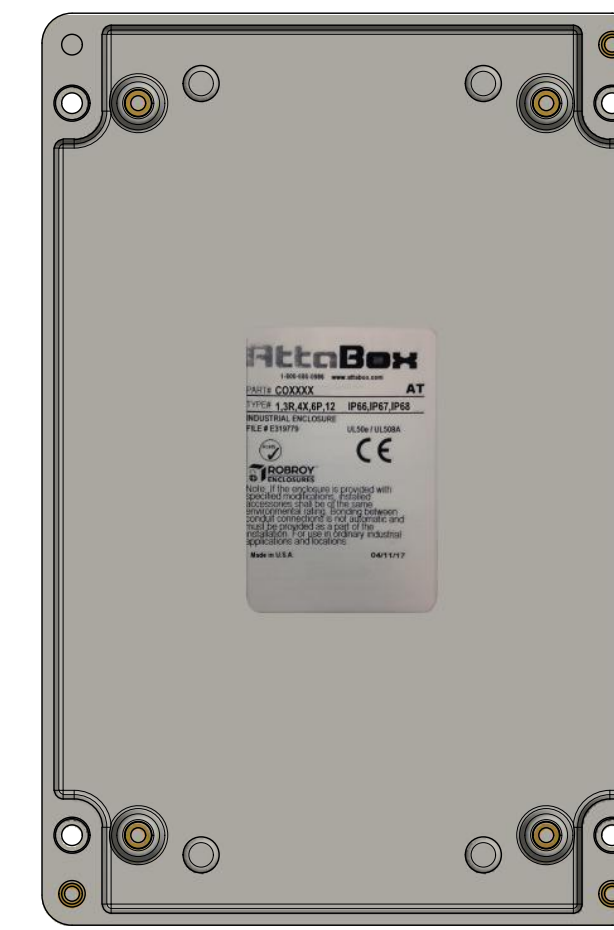

PRODUCT LABEL DETAIL (BOX)

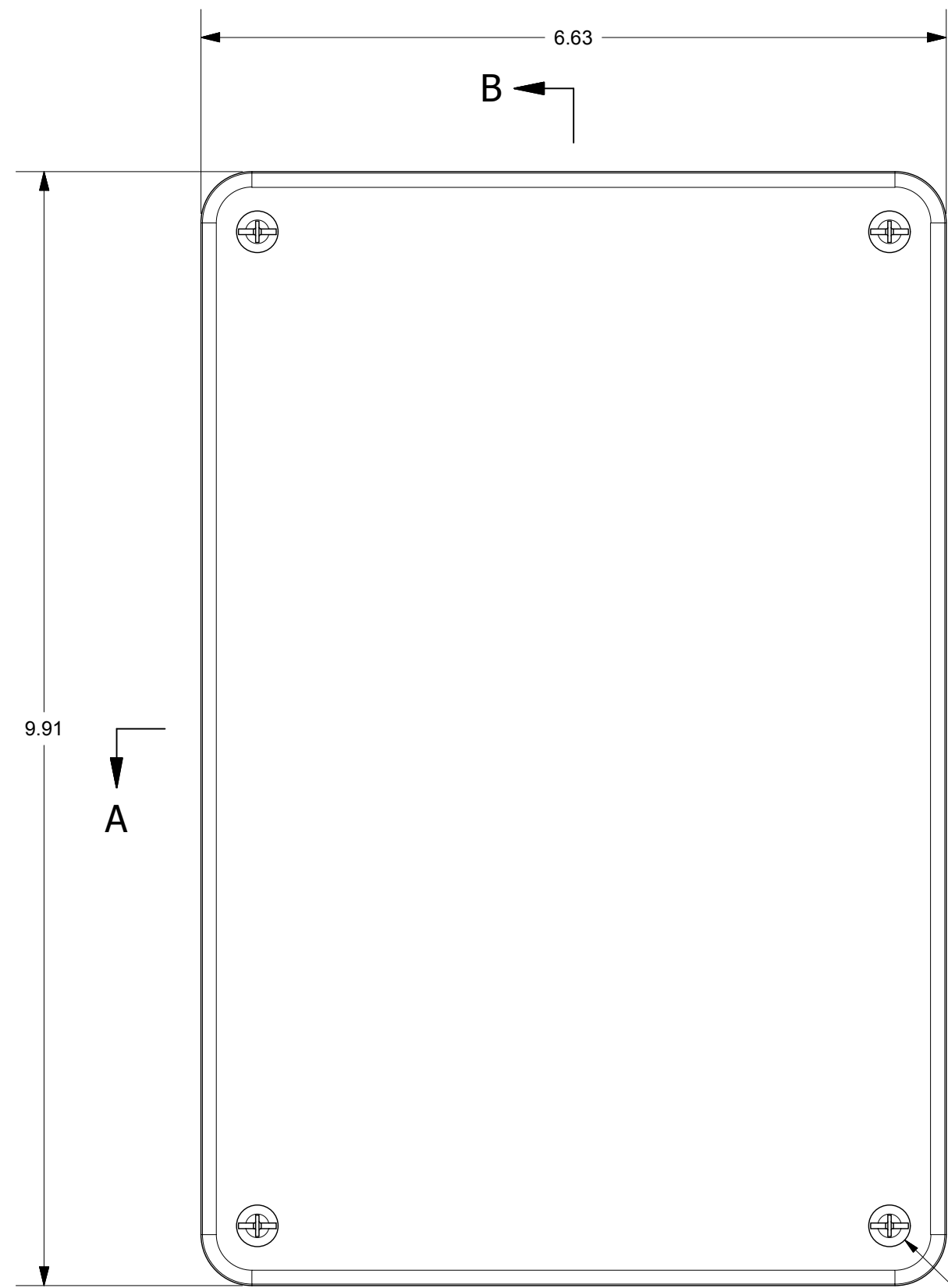
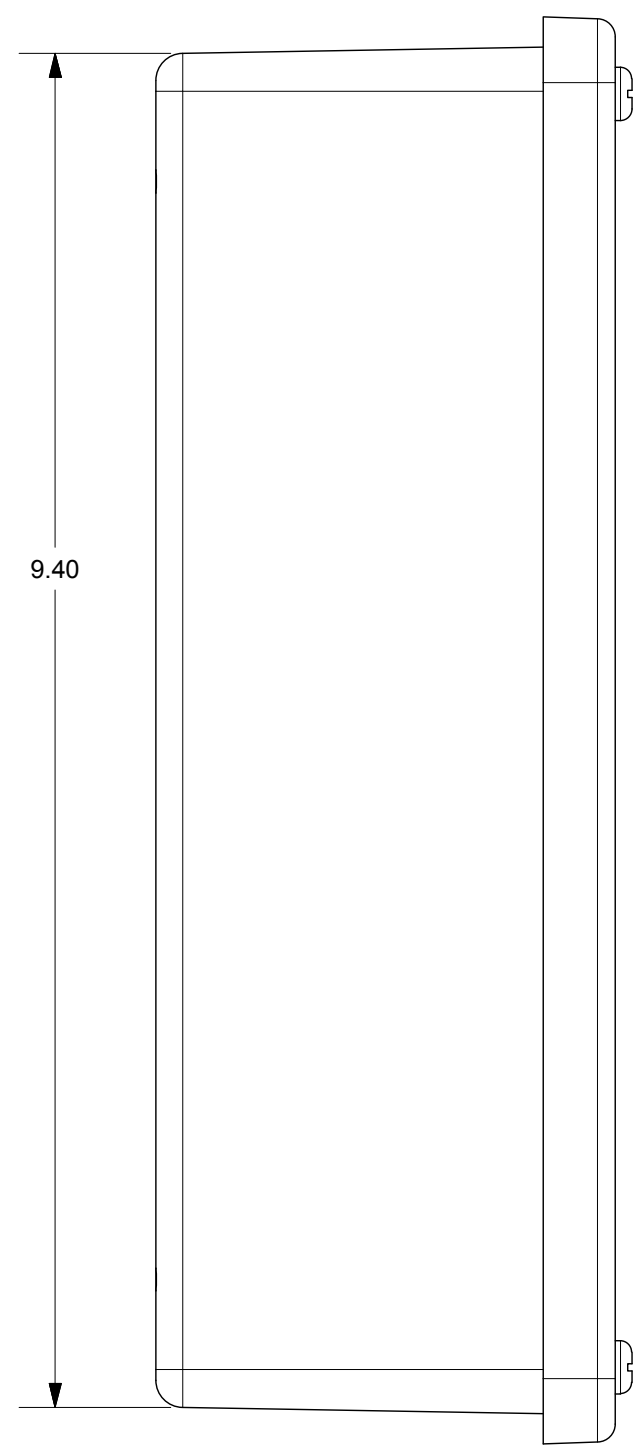
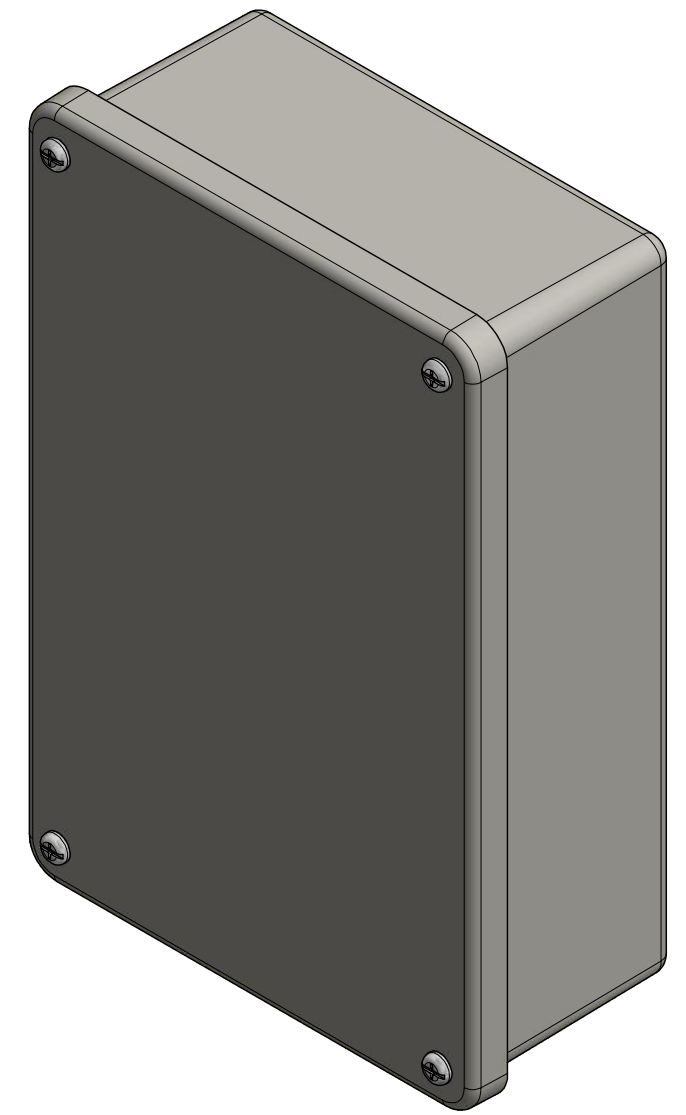

#10-24 X 3/4 COVER SCREW (RMSC10-24X3/4COMBO) (4X)

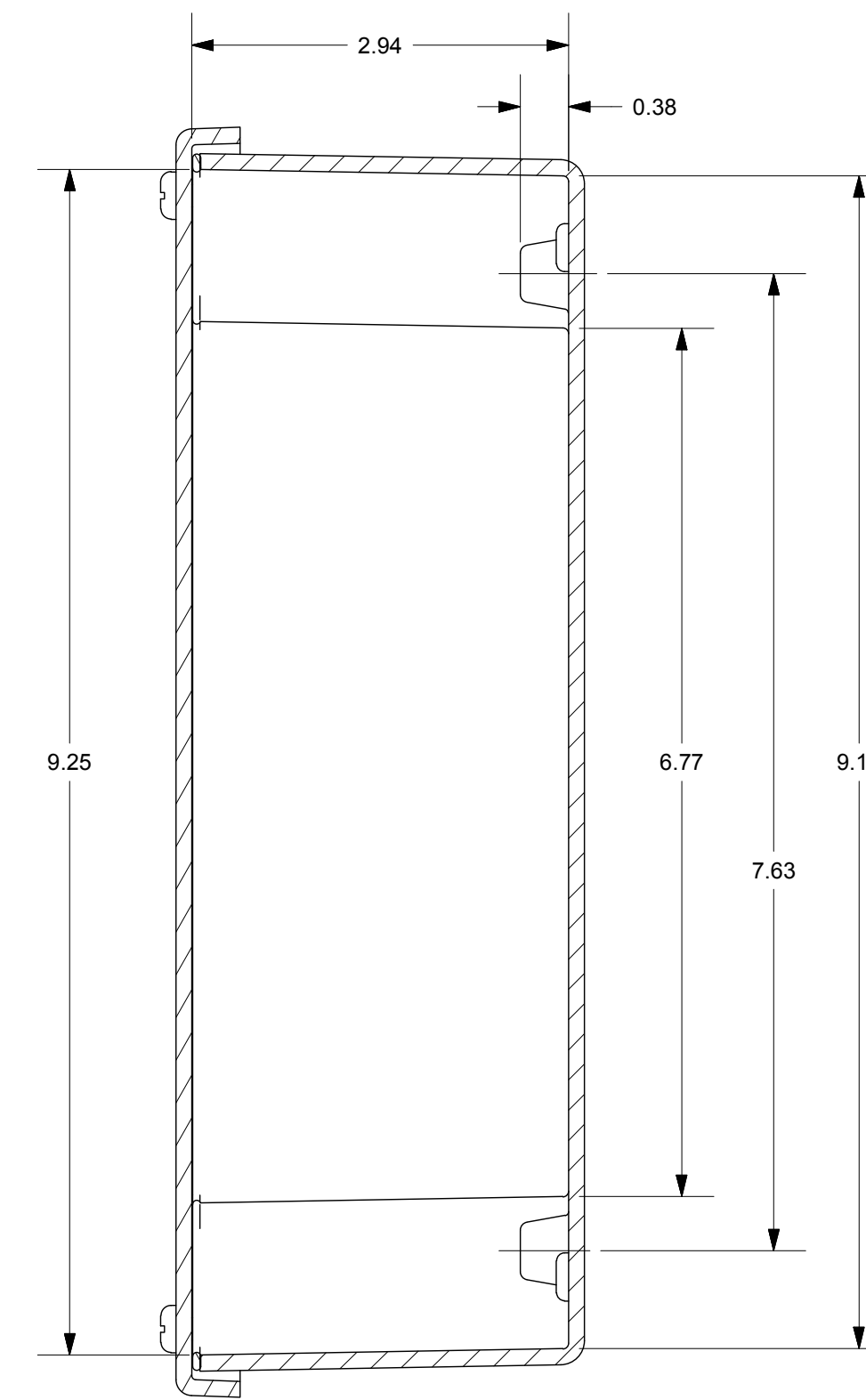

SECTION B-B

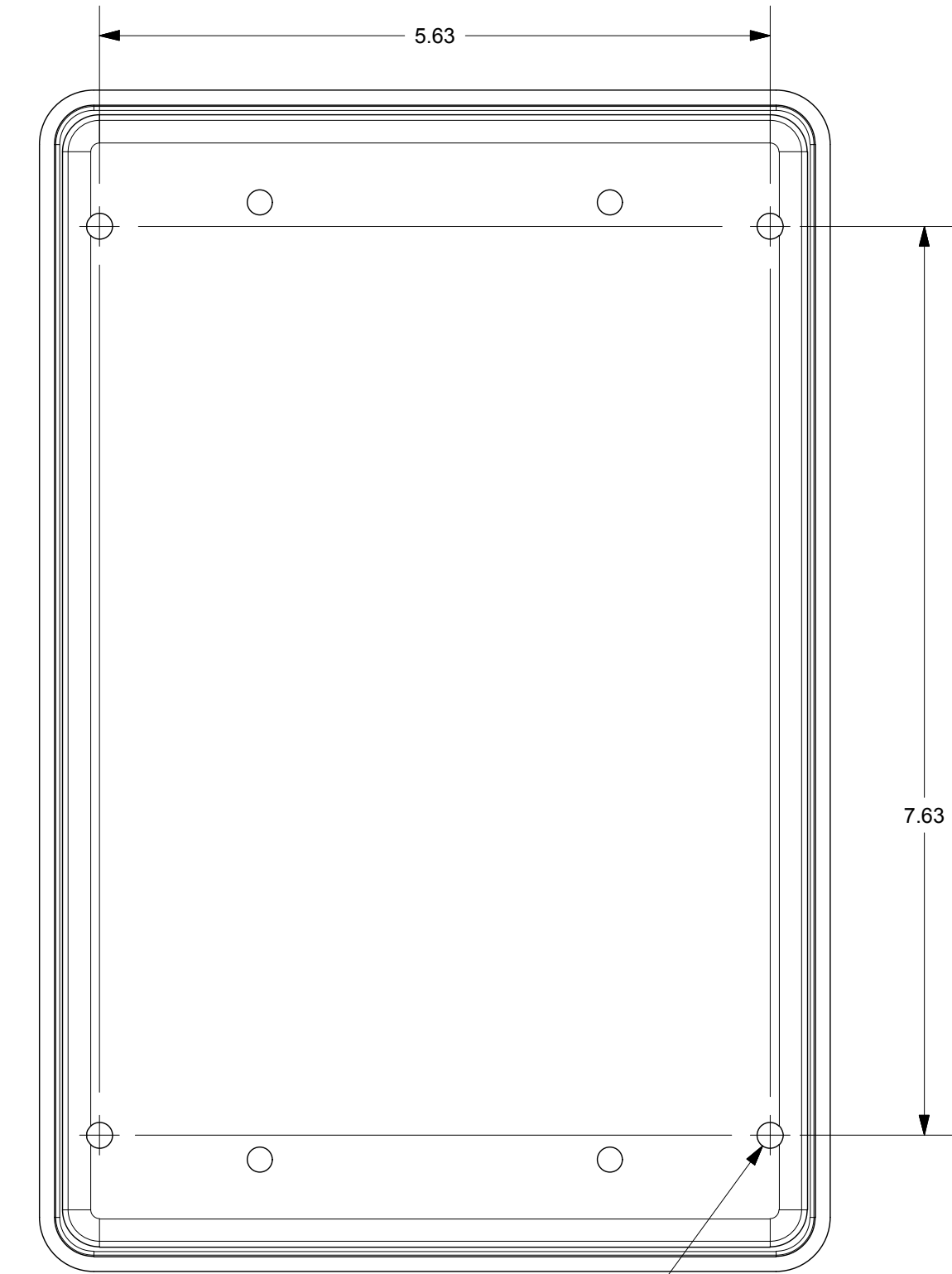

4X Ø0.22

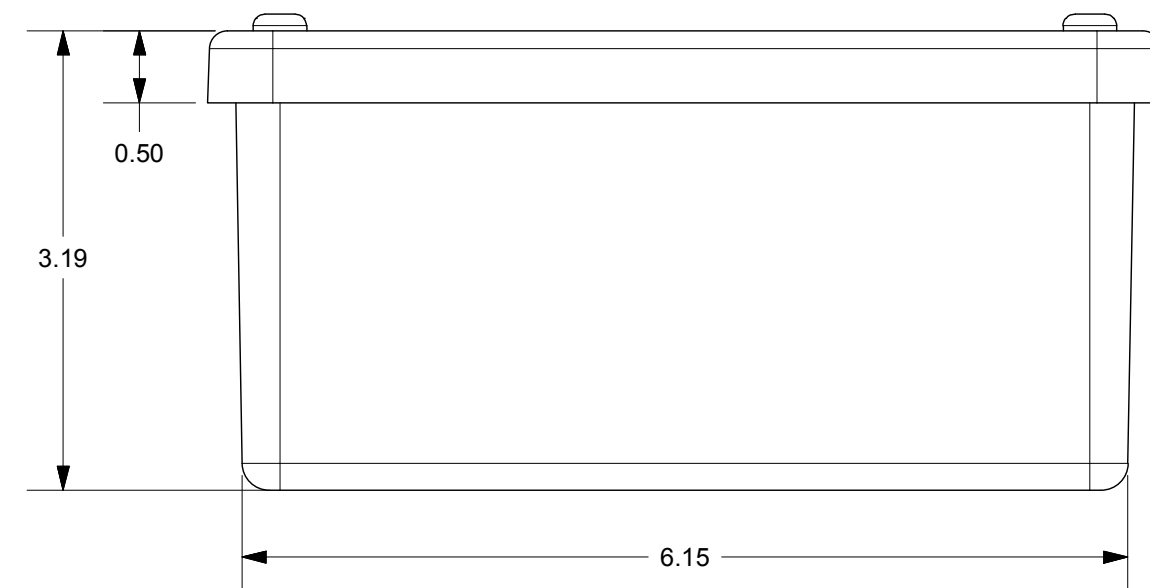

**END USER NOTES:**  
1. TORQUE COVER SCREWS TO 20-24 IN.-LBS. TO MAINTAIN RATINGS

THIS DRAWING IS THE SOLE AND EXCLUSIVE PROPERTY OF ROBROY ENCLOSURES. NO PART OF THIS DRAWING MAY BE REPRODUCED, DISTRIBUTED, OR PUBLICALLY DISPLAYED IN ANY FORM OR BY ANY MEANS WITHOUT THE EXPRESS WRITTEN PERMISSION OF ROBROY ENCLOSURES. ALL RIGHTS RESERVED. UNDER THE COPYRIGHT LAWS. COPYRIGHT © 2017 ROBROY ENCLOSURES

**SPECIAL REQUIREMENTS**

NEMA 250: TYPE 1, 3R, 4X, 6P, 12 IEC 60529: IP66, IP67, IP68 COLOR: GLACIER GRAY (WPR3013) COLOR STANDARD: PANTONE 428 C		STANDARD P/N: CO963 CUSTOMER DWG:	ALL DIMENSIONS ARE IN INCHES UNLESS OTHERWISE SPECIFIED	TOLERANCES UNLESS SPECIFIED .XX ± 0.03 .XXX ± 0.010																																						
MATERIAL: FIBERGLASS REINFORCED POLYESTER (FRP)		 <p><b>Robroy Enclosures</b> 500 Maple Street Belding, Michigan 48809 Phone: 616-794-0700 Fax: 616-749-3378</p>																																								
<table border="1"> <thead> <tr> <th>REV</th> <th>DESCRIPTION</th> <th>DATE</th> <th>ENG</th> </tr> </thead> <tbody> <tr><td>-</td><td>-</td><td>-</td><td>-</td></tr> <tr><td>-</td><td>-</td><td>-</td><td>-</td></tr> <tr><td>-</td><td>-</td><td>-</td><td>-</td></tr> <tr><td>-</td><td>-</td><td>-</td><td>-</td></tr> <tr><td>-</td><td>-</td><td>-</td><td>-</td></tr> <tr><td>-</td><td>-</td><td>-</td><td>-</td></tr> </tbody> </table>					REV	DESCRIPTION	DATE	ENG	-	-	-	-	-	-	-	-	-	-	-	-	-	-	-	-	-	-	-	-	-	-	-	-										
REV	DESCRIPTION	DATE	ENG																																							
-	-	-	-																																							
-	-	-	-																																							
-	-	-	-																																							
-	-	-	-																																							
-	-	-	-																																							
-	-	-	-																																							
<table border="1"> <thead> <tr> <th>REV</th> <th>DESCRIPTION</th> <th>DATE</th> <th>ENG</th> </tr> </thead> <tbody> <tr><td>-</td><td>-</td><td>-</td><td>-</td></tr> <tr><td>-</td><td>-</td><td>-</td><td>-</td></tr> <tr><td>-</td><td>-</td><td>-</td><td>-</td></tr> <tr><td>-</td><td>-</td><td>-</td><td>-</td></tr> <tr><td>-</td><td>-</td><td>-</td><td>-</td></tr> <tr><td>-</td><td>-</td><td>-</td><td>-</td></tr> <tr><td>-</td><td>-</td><td>-</td><td>-</td></tr> </tbody> </table>		REV	DESCRIPTION	DATE	ENG	-	-	-	-	-	-	-	-	-	-	-	-	-	-	-	-	-	-	-	-	-	-	-	-	-	-	-	-	<table border="1"> <tr> <td>DRAWN BY: E91</td> <td>DATE: 05/17/17</td> <td>CUSTOMER:</td> <td>DWG: CO963</td> </tr> <tr> <td>SCALE: DO NOT SCALE</td> <td>DESCRIPTION: STANDARD ENCLOSURE</td> <td>PART NUMBER: ATCO963</td> <td></td> </tr> </table>	DRAWN BY: E91	DATE: 05/17/17	CUSTOMER:	DWG: CO963	SCALE: DO NOT SCALE	DESCRIPTION: STANDARD ENCLOSURE	PART NUMBER: ATCO963	
REV	DESCRIPTION	DATE	ENG																																							
-	-	-	-																																							
-	-	-	-																																							
-	-	-	-																																							
-	-	-	-																																							
-	-	-	-																																							
-	-	-	-																																							
-	-	-	-																																							
DRAWN BY: E91	DATE: 05/17/17	CUSTOMER:	DWG: CO963																																							
SCALE: DO NOT SCALE	DESCRIPTION: STANDARD ENCLOSURE	PART NUMBER: ATCO963																																								

