

SECTION A-A

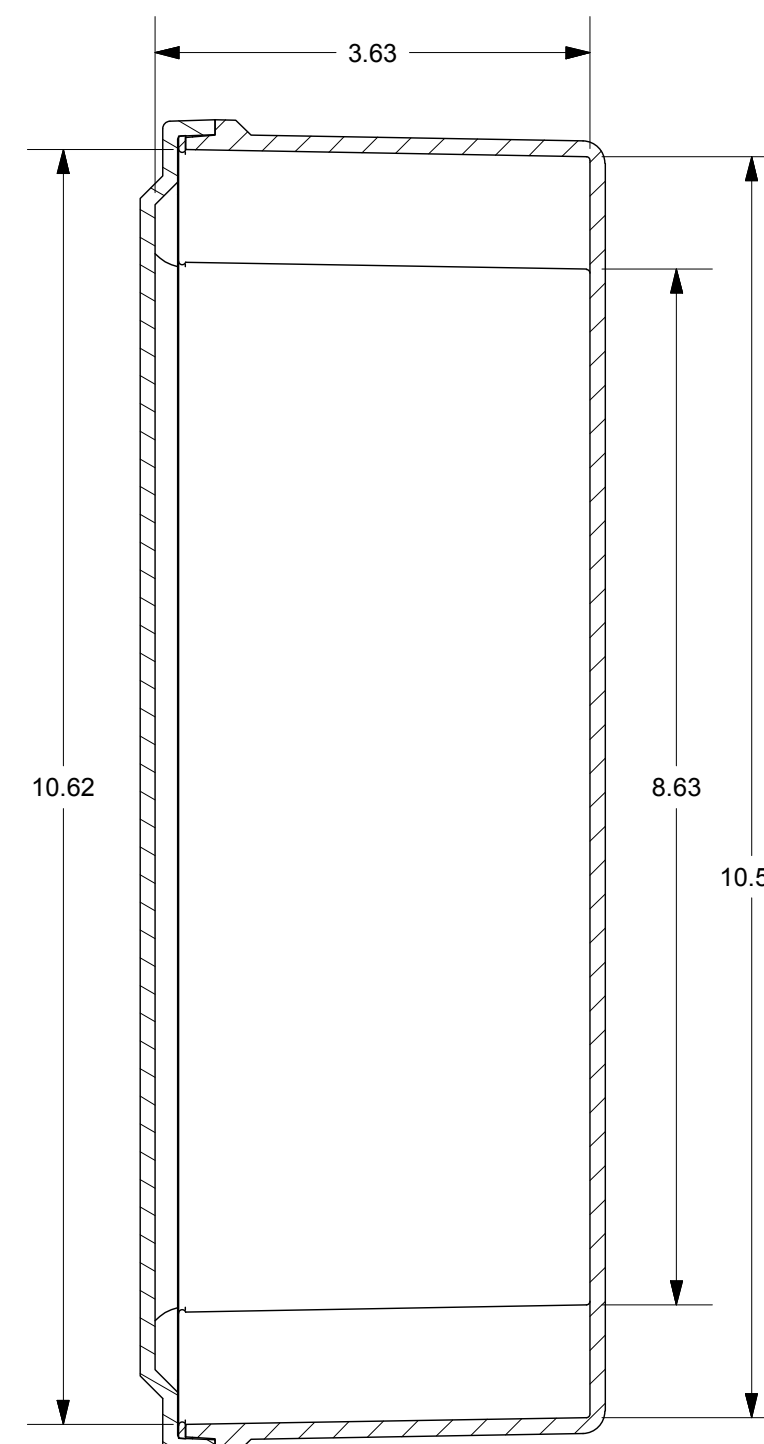

PRODUCT LABEL DETAIL (BOX)

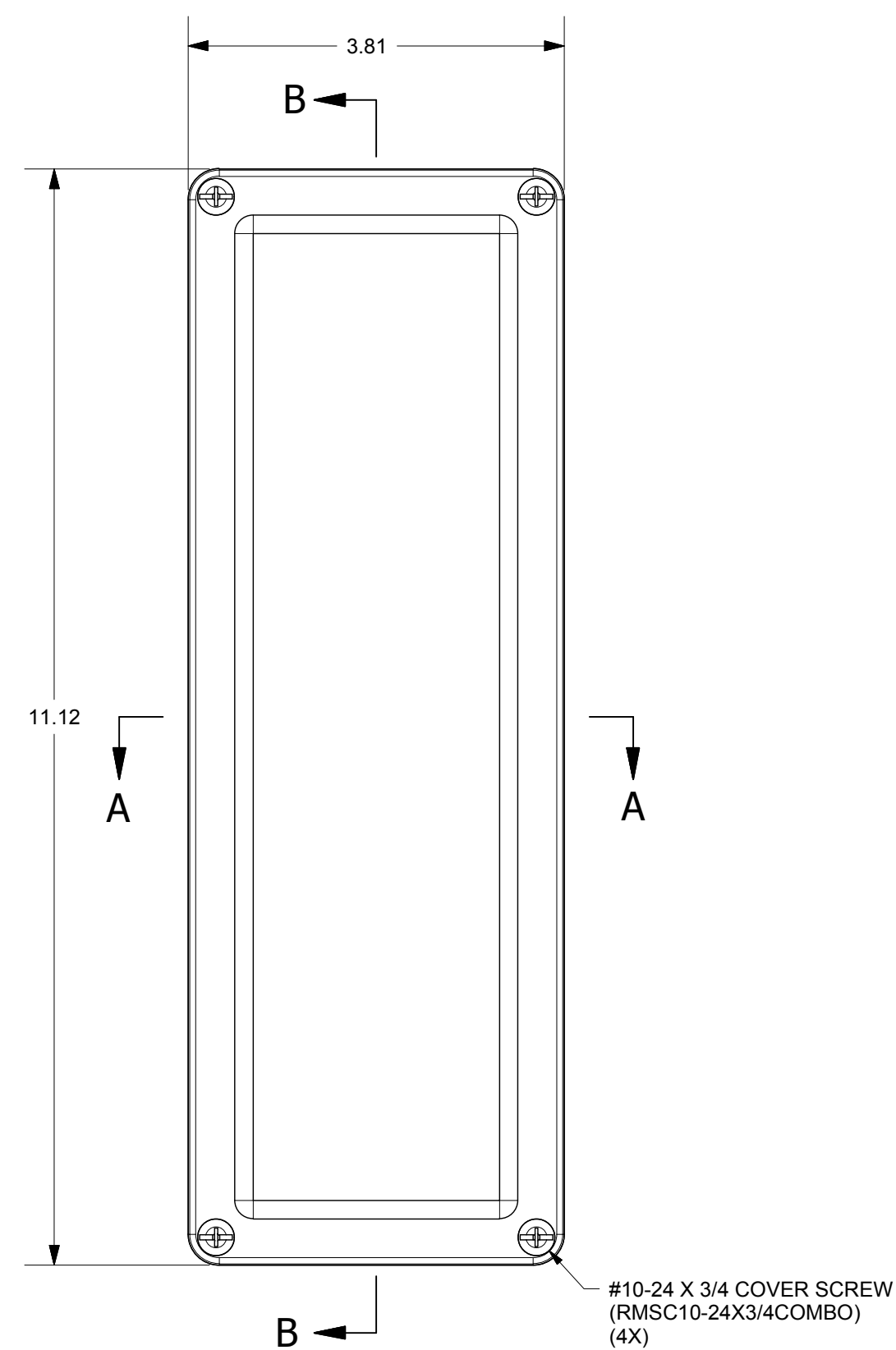
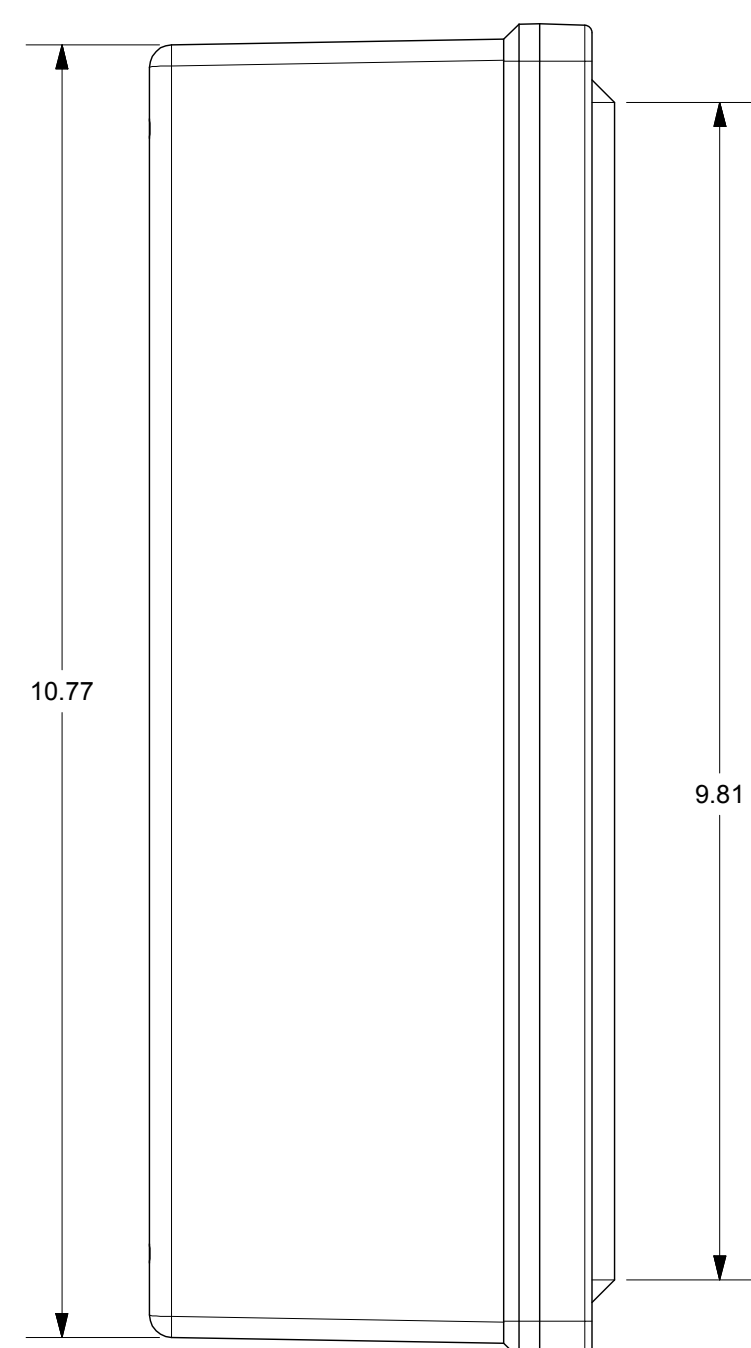
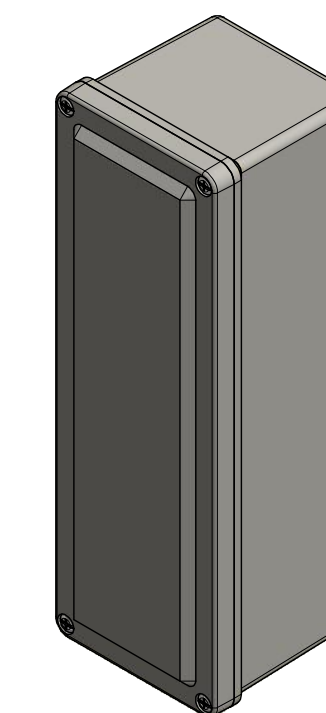

SECTION B-B

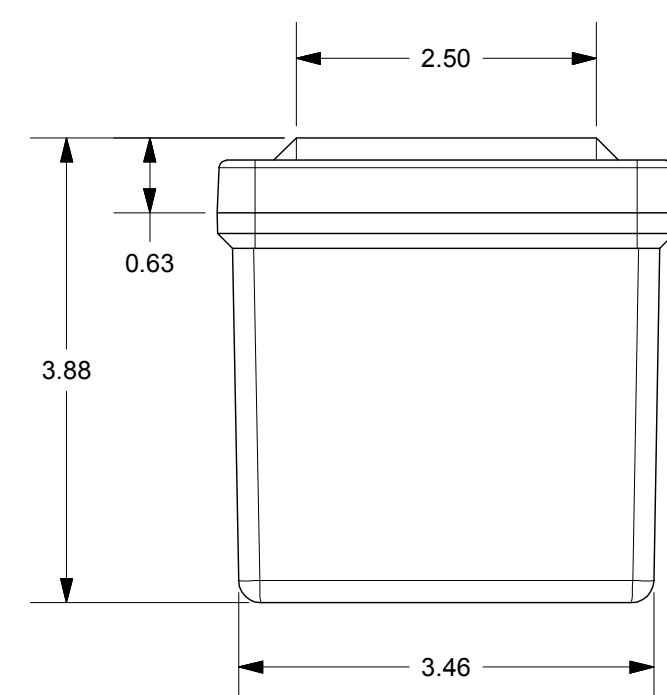
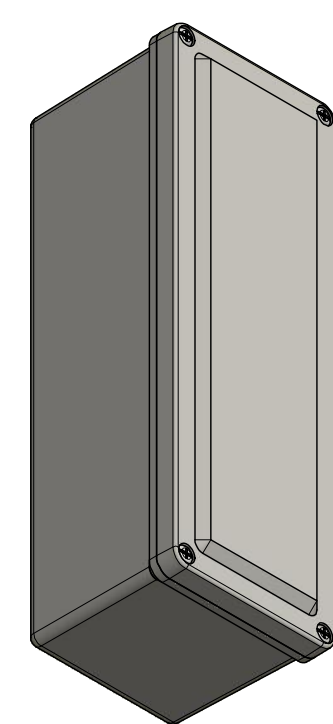
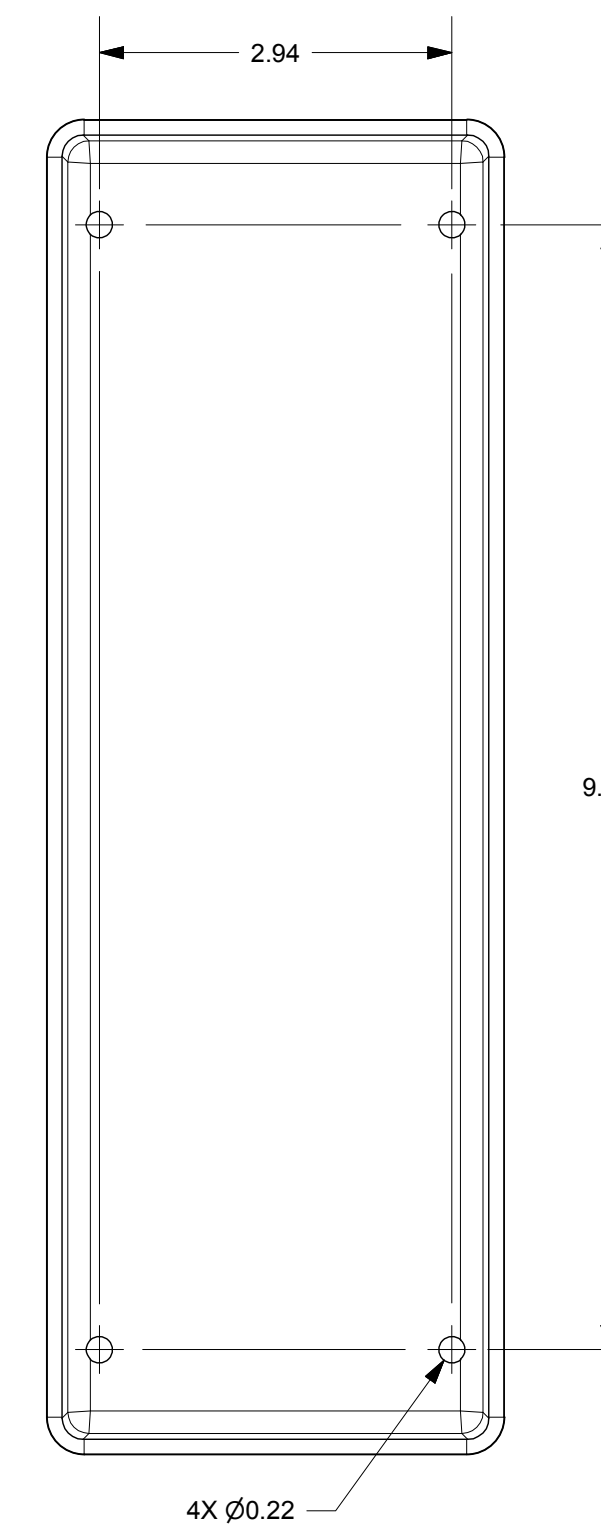

THIS DRAWING IS THE SOLE AND EXCLUSIVE PROPERTY OF ROBROY ENCLOSURES. NO PART OF THIS DRAWING MAY BE REPRODUCED, DISTRIBUTED, OR PUBLICALLY DISPLAYED IN ANY FORM OR BY ANY MEANS WITHOUT THE EXPRESS WRITTEN PERMISSION OF ROBROY ENCLOSURES. ALL RIGHTS RESERVED. UNDER THE COPYRIGHT LAWS. COPYRIGHT © 2017 ROBROY ENCLOSURES.

**END USER NOTES:**  
1. TORQUE COVER SCREWS TO 20-24 IN.-LBS. TO MAINTAIN RATINGS

**SPECIAL REQUIREMENTS**

NEMA 250: TYPE 1, 3R, 4X, 6P, 12 IEC 60529: IP66, IP67, IP68 COLOR: GLACIER GRAY (WPR3013) COLOR STANDARD: PANTONE 428 C		STANDARD P/N: CO1144	ALL DIMENSIONS ARE IN INCHES UNLESS OTHERWISE SPECIFIED	TOLERANCES UNLESS SPECIFIED	.XX ± 0.03 .XXX ± 0.010
MATERIAL: FIBERGLASS REINFORCED POLYESTER (FRP)		CUSTOMER DWG:	 <p><b>Robroy Enclosures</b> 500 Maple Street Belding, Michigan 48809 Phone: 616-794-0700 Fax: 616-749-3378</p>		
REVISION HISTORY					
REV	DESCRIPTION	DATE	ENG		
-	-	-	-		
-	-	-	-		
-	-	-	-		
-	-	-	-		
-	-	-	-		
-	-	-	-		
DRAWN BY: E91		DATE: 05/17/17	CUSTOMER		
SCALE: DO NOT SCALE		DESCRIPTION: STANDARD ENCLOSURE	PART NUMBER: ATCO1144		DWG: CO1144