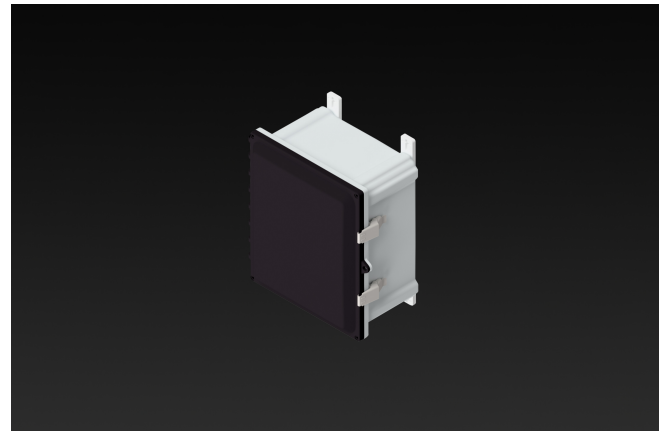

Enclosures **Heartland Series****Polycarbonate Enclosure 12 x 10 x 6 Inches Heartland with Clear Cover with Stainless Steel Latches****Catalog Number** AH12106CSS**UPC** 19156411689.0

List Price

**\$260.91****Description**

12H x 10W x 6D Inches Heartland (AH) Series is a high performance, polycarbonate enclosure applicable for heavy industrial conditions, but with a refined style suitable for commercial, industrial and OEM design applications. Heartland Series enclosures are rain-tight and watertight rated for use in both interior and exterior applications. This configuration features a clear cover which is hinged, latched and padlockable with stainless steel latches.

**Application**

Suitable for heavy industrial; commercial; and OEM applications

**Features**

- Latches and hinges do not penetrate enclosure
- Easy to remove lid
- High performance inserts
- integrated padlock hasp
- Flush-fit side mount swing panel and DIN rail system
- Molded in bosses
- Multi-directional mounting feet

- Single SKU with multiple cover attachment options

## General Information

<b>Color</b>	Gray
<b>Cover Type</b>	Clear
<b>Mounting Type</b>	Wall Mount
<b>Material</b>	Polycarbonate
<b>Back Panel Screw Size</b>	#10-32x3/8
<b>Back Panel Recommended Torque</b>	16-20 in-lbs.
<b>Back Panel Screw Material</b>	Zinc Plated
<b>Cover Screw Size</b>	#10-32 x 5/8
<b>Cover Screw Recommended Torque</b>	20-24 in-lbs.
<b>Cover Screw Material</b>	304 SS
<b>Mounting Foot Screw Size</b>	1/4-20 x 1/2
<b>Mounting Foot Screw Recommended Torque</b>	10-14 in-lbs.
<b>Installation Mounting Torque</b>	25-30 in-lbs. Max
<b>Metal Inserts</b>	Brass
<b>Hinge Material</b>	Integral Polycarbonate
<b>Latch Material</b>	316 SS
<b>Gasket Material</b>	Poured In Place (PIP) Polyurethane Seamless
<b>Country of Origin</b>	USA

## Dimensions

<b>Height (in)</b>	12.0
<b>Width (in)</b>	10.0
<b>Depth (in)</b>	6.0
<b>Height (mm)</b>	305.0
<b>Width (mm)</b>	254.0
<b>Depth (mm)</b>	152.0
<b>Useable Depth (in)</b>	6.6
<b>Useable Depth (mm)</b>	167.0

## Standards

---

<b>NEMA 250; UL 50; UL 50e; UL508A</b>	cULus Listed File #E319779
<b>Type</b>	1; 3R; 4; 4X; 12
<b>IEC 60529</b>	
<b>Temperature Range °F</b>	-40°F to +248°F
<b>Temperature Range °C</b>	-40°C to +120°C
<b>Flammability Rating</b>	UL94-5VA
<b>Outdoor Exposure UL746c</b>	(f1) Rated
<b>CE</b>	Certified

Latch Material  
Stainless Steel